

High Frequency Ceramic Solutions

NXP (Freescale) KW40, KW30, and KW20 Impedance Matched Front End Balun + BPF (FCC/ETSI-compliant filter embedded) P/N: 2450BM15B0026

Detail Specification: 5/26/2016

Page 1 of 5

AEC-Q200 available

General Specifications

Part Number	2450BM15B0026
Frequency (MHz)	2400-2500
Unbalanced Impedance	50
Balanced Impedance	Conj. match to NXP Freescale KW40/30/20 RF Chipsets*
Insertion Loss	1.0 dB Typ (1.5 dB max.)
Return Loss	9.5 dB min.
Phase Diff.	180±10 deg.
Amp. Diff.	2.0 max.
Attenuation	15 dB min. @ 1170 MHz 22 dB min. @ 4800~5000MHz 18 dB min. @ 7200~7500 MHz
Q'ty/Reel	4,000 pcs
Power Capacity	2W max. CW

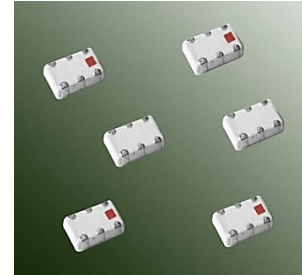

Operating Temperature	-40°C to +85°C
Storage Temperature Range	-40°C to +85°C
Storage Period	18 months max
Recommended Storage Conditions for unused product on T&R	+5 to +35°C, Humidity: 45-75%RH, 18 mos. Max

*Do you need help with the layout (free service)? Send us a message and we'll put you in touch with an RF Engineer!
www.johansontechnology.com/ask-a-question

Mechanical Dimensions

	In	mm
L	0.079 ± 0.004	2.00 ± 0.10
W	0.049 ± 0.004	1.25 ± 0.10
T	0.028 ± 0.004	0.70 ± 0.10
a	0.012 ± 0.004	0.30 ± 0.10
b	0.008 ± 0.004	0.20 ± 0.10
c	0.012 +.004/-.008	0.30 +0.1/-0.2
g	0.014 ± 0.004	0.35 ± 0.10
p	0.026 ± 0.002	0.65 ± 0.05

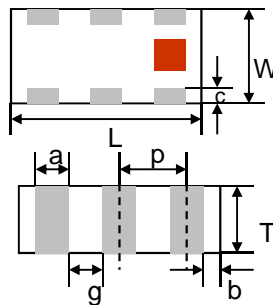

Terminal Configuration

No.	Function	No.	Function
1	Unbalanced Port	4	Balanced Port
2	GND or DC Feed	5	GND
3	Balanced Port	6	GND

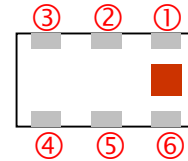

Part Number Explanation

P/N Suffix	Packing Style			
		Bulk	Suffix = S	eg. 2450BM15B0026S
		T & R	Suffix = E	eg. 2450BM15B0026E
		100% Tin	Suffix = None	eg. 2450BM15B0026(E or S)

Download the measured s-parameters (to simulate our component), schematic, and gerber/layout files at:
www.johansontechnology.com/nxp

Johanson Technology, Inc. reserves the right to make design changes without notice.
 All sales are subject to Johanson Technology, Inc. terms and conditions.



www.johansontechnology.com

4001 Calle Tecate • Camarillo, CA 93012 • TEL 805.389.1166 FAX 805.389.1821

Ver. 1.2

2016 Johanson Technology, Inc. All Rights Reserved

High Frequency Ceramic Solutions

NXP (Freescale) KW40, KW30, and KW20 Impedance Matched Front End P/N: 2450BM15B0026
Balun + BPF (FCC/ETSI-compliant filter embedded)

Detail Specification: 5/26/2016

Page 2 of 5

AEC-Q200 available

Schematic

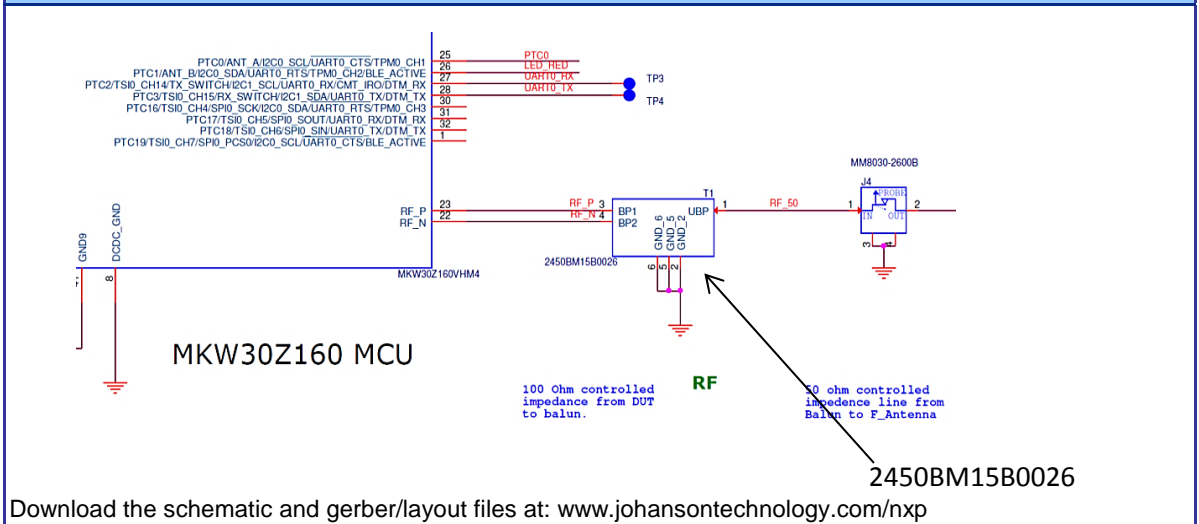

Layout Mounting Considerations

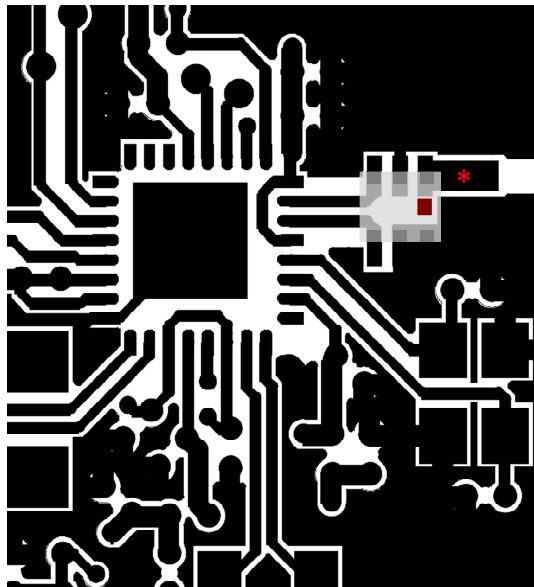

Need help with the layout of the component or help choosing a mini 2.4GHz antenna? Contact us at: www.johansontechnology.com/ask-a-question

* Line width should be designed to match 50ohm characteristic impedance, depending on PCB material and thickness. Grounded CPWG is recommended.

Download the complete layout file at at: www.johansontechnology.com/nxp

Johanson Technology, Inc. reserves the right to make design changes without notice.
All sales are subject to Johanson Technology, Inc. terms and conditions.



www.johansontechnology.com

4001 Calle Tecate • Camarillo, CA 93012 • TEL 805.389.1166 FAX 805.389.1821

Ver. 1.2

2016 Johanson Technology, Inc. All Rights Reserved

High Frequency Ceramic Solutions

NXP (Freescale) KW40, KW30, and KW20 Impedance Matched Front End Balun + BPF (FCC/ETSI-compliant filter embedded) P/N: 2450BM15B0026

Detail Specification: 5/26/2016

Page 3 of 5

AEC-Q200 available

Mounting Considerations

Without DC Feed

With DC Feed

6.8pF RF GND (DC block) cap
 Johanson p/n:
 (EIA0201) 250R05L6R8CV4T
 (EIA0402) 201R07S6R8CV4T
 (EIA 0603) 251R14S6R8CV4T

By-pass Capacitor (6.8pF chip Capacitor)
 Solder Resist
 Land
 Through-hole (ϕ 0.3/0.55)

*Line width should be designed to match 50ohm characteristic impedance, depending on PCB material and thickness.

Mounting Diagram

Port 3: Unbalanced Port
 Ports 1 and 2: Balanced Port
 $IL = S_{ds21}$
 $RL = S_{ss11}, S_{dd22}$
 $Amp_balance = dB(S(2,3)/S(1,3))$
 $Phase_balance = Phase(S(2,3)/S(1,3))$

*Impedance for ports 1 and 2
 = Conjugate to Balanced Impedance/2
 **E5071B from Agilent

Johanson Technology, Inc. reserves the right to make design changes without notice.
 All sales are subject to Johanson Technology, Inc. terms and conditions.

High Frequency Ceramic Solutions

NXP (Freescale) KW40, KW30, and KW20 Impedance Matched Front End P/N: 2450BM15B0026
Balun + BPF (FCC/ETSI-compliant filter embedded)

Detail Specification: 5/26/2016

Page 4 of 5

AEC-Q200 available

Typical Electrical Characteristics (T=25°C)

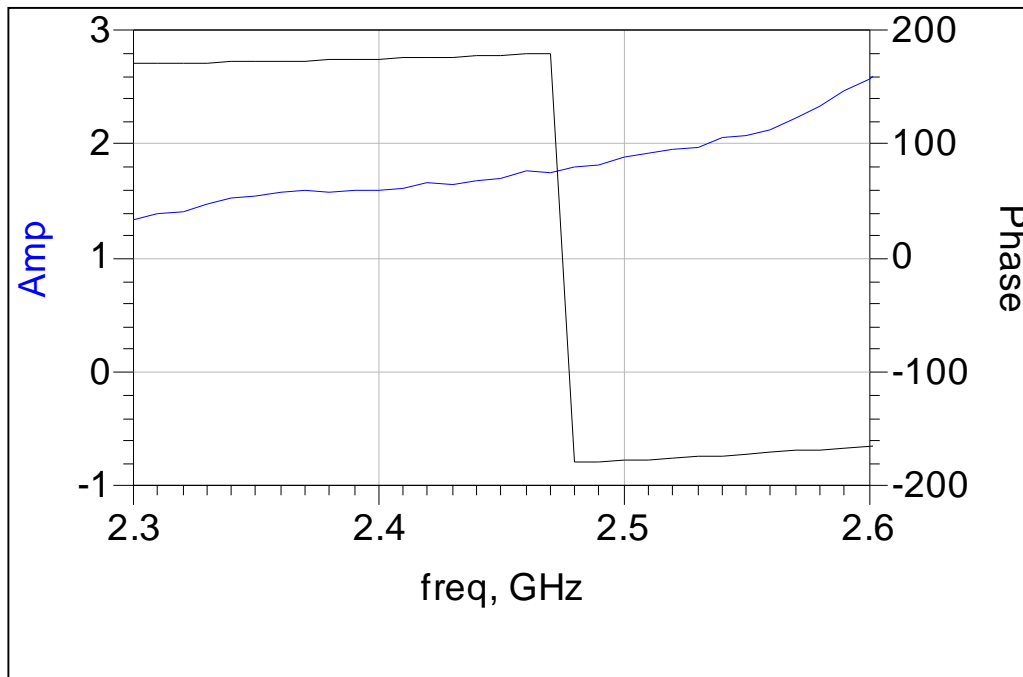
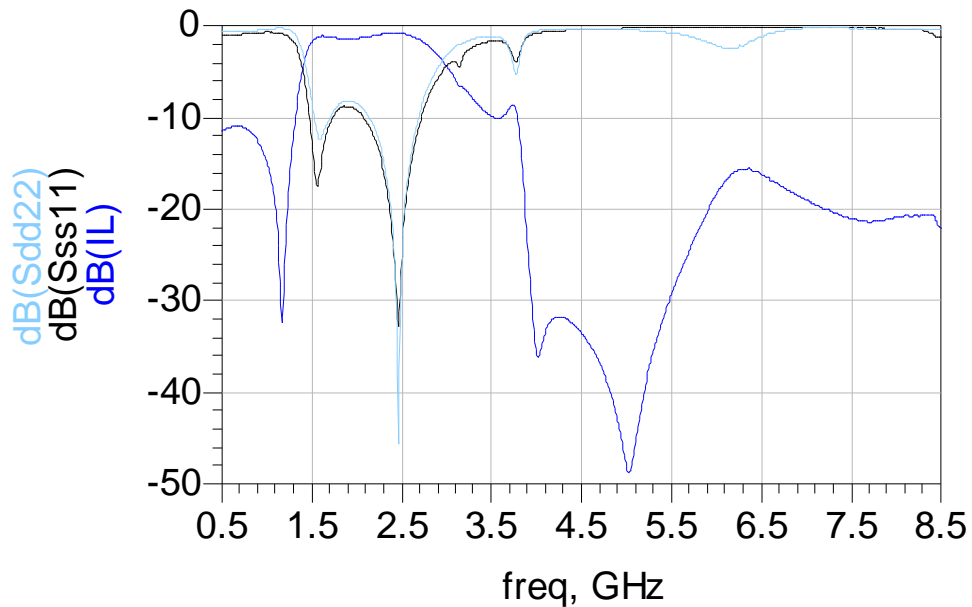

Johanson Technology, Inc. reserves the right to make design changes without notice.
All sales are subject to Johanson Technology, Inc. terms and conditions.



"High Frequency Ceramic Solutions"

NXP (Freescale) KW40, KW30, and KW20 Impedance Matched Front End Balun + BPF (FCC/ETSI-compliant filter embedded) P/N: 2450BM15B0026

Detail Specification: 5/26/2016

Page 5 of 5

AEC-Q200 available

Application Notes, Layout Files, and more

www.johansontechnology.com/nxp

Mini Antennas for BLE applications

www.johansontechnology.com/antennas

Antenna layout and tuning techniques

www.johansontechnology.com/tuning

Antenna layout review, tuning, and characterization services

www.johansontechnology.com/ipc-antenna-services.html

Soldering Information

www.johansontechnology.com/ipcsoldering-profile

MSL Info

www.johansontechnology.com/msl-rating

Recommended Storage Condition and Max Shelf Life

<http://www.johansontechnology.com/recommended-storage-conditions>

Packaging information

www.johansontechnology.com/ipcpackaging.html

RoHS Compliance

www.johansontechnology.com/rohs-compliance

Johanson Technology, Inc. reserves the right to make design changes without notice.

All sales are subject to Johanson Technology, Inc. terms and conditions.



www.johansontechnology.com
4001 Calle Tecate • Camarillo, CA 93012 • TEL 805.389.1166 FAX 805.389.1821

Ver. 1.2

2016 Johanson Technology, Inc. All Rights Reserved

Mouser Electronics

Authorized Distributor

Click to View Pricing, Inventory, Delivery & Lifecycle Information:

[Johanson:](#)

[2450BM15B0026E](#)